



**TECHNICAL CHARACTERISTICS**

- Aluminium alloy construction
- Smooth operation
- High efficiency impeller
- Maintenance free
- Mountable in any position
- Recognized TEFC - cURus motor

**OPTIONS**

- Special voltages (IEC 38)
- Surface treatments

**ACCESSORIES**

- Inlet and/or inline filters
- Additional inlet/outlet silencers
- Safety valves
- Flow converting device
- Optional connectors

Dimensions in inches.  
Dimension for reference only.

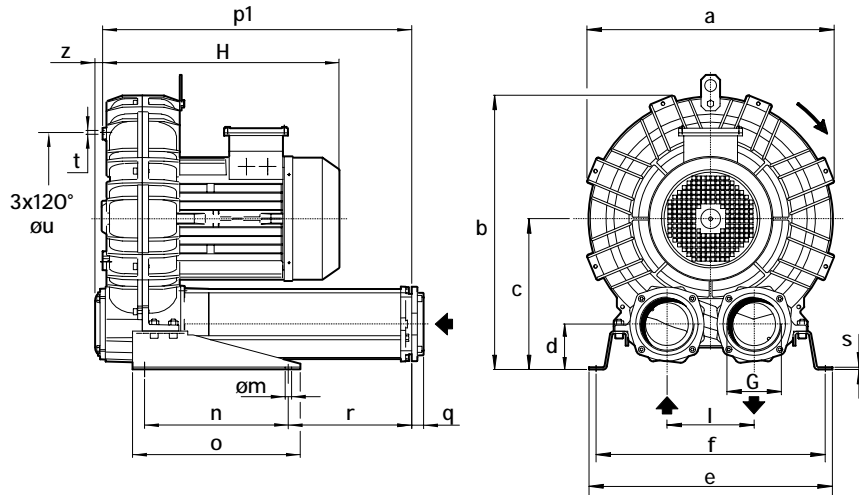

Model	a	b	c	d	e	f	G	l	m	n	o	p1	q	r	s	t	u	z
K07R-MD	16.69	18.94	10.59	3.23	18.43	17.24	2" NPT	6.10	0.51	11.81	13.78	16.46	0.71	1.70	0.20	M8	11.61	0.63
K08R-MD	17.99	19.61	10.59	3.23	18.82	17.64	2" NPT	6.10	0.51	11.81	13.78	16.46	0.71	1.70	0.20	M8	12.20	0.63
K09-MD	19.37	22.09	12.40	3.78	20.00	18.82	4" NPT	7.17	0.51	11.81	13.78	25.35	0.98	10.12	0.20	M8	14.17	0.63
K10-MD	20.31	22.56	12.40	3.78	20.00	18.82	4" NPT	7.17	0.51	11.81	13.78	25.35	0.98	10.12	0.20	M8	14.17	0.63
K11-MD	21.35	23.74	13.07	3.58	21.18	20.00	4" NPT	7.87	0.51	11.81	13.78	25.75	0.98	10.31	0.20	M8	15.35	0.63
K12-MD	21.57	23.85	13.07	3.58	21.18	20.00	4" NPT	7.87	0.51	11.81	13.78	25.87	0.98	10.31	0.20	M8	15.35	0.62

Model	Maximum flow Scfm		Installed power Hp		Maximum differential pressure p (In WG)		Noise level Lp dB (A) (1)		Overall dimensions H Inches	Weight Lbs
	60 Hz 3500 rpm	50 Hz 2900 rpm	60 Hz 3500 rpm	50 Hz 2900 rpm	60 Hz 3500 rpm	50 Hz 2900 rpm	60 Hz 3500 rpm	50 Hz 2900 rpm		
K07R-MD	129	107	5 1/2	5 1/2	150	220	74.5	72.5	16.30	117
			7 1/2	7 1/2	231	260	75.0	73.0	17.60	159
			10	10	280	-	75.0	73.0	19.10	171
K08R-MD	168	139	5 1/2	5 1/2	85	140	76.2	74.2	16.30	125
			7 1/2	7 1/2	151	200	76.6	74.6	17.60	167
			10	10	220	260	77.0	75.0	19.10	179
K09-MD	221	183	15	-	260	-	77.3	-	19.10	192
			10	10	190	250	79.5	77.5	19.50	210
K10-MD	275	228	15	15	290	-	80.5	78.5	19.50	223
			10	10	130	200	80.3	78.3	19.50	214
K11-MD	306	254	15	15	240	260	81.4	79.4	19.50	228
			20	20	260	-	81.7	79.7	22.00	264
K12-MD	336	278	15	15	180	260	81.4	79.4	19.70	244
			20	20	280	-	81.7	79.7	22.50	280
			25	-	100	180	82.3	80.3	19.90	242
			20	20	180	260	82.6	80.6	22.50	278
			25	-	240	-	82.9	-	25.00	362

(1) Noise measured at 1 m distance with inlet and outlet ports piped, in accordance to ISO 3744.

- For proper use, the blower should be equipped with inlet filter and safety valve; other accessories available on request.
- Ambient temperature from +5° to +104°F.
- Specifications subject to change without notice.



SCL K07R / K08R / K09 / K10 / K11 / K12

MD SERIES  
SN 1848-13B 2/2

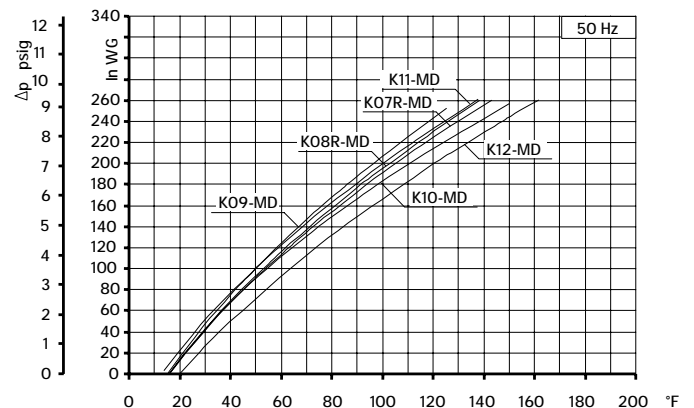
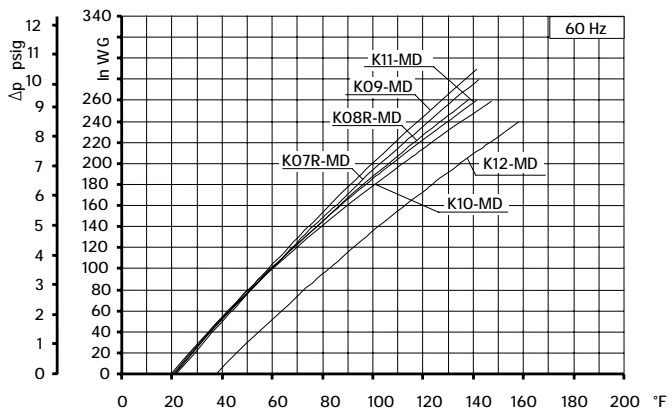
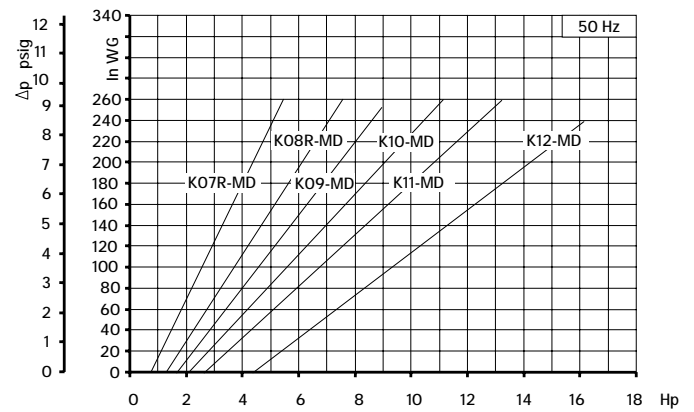
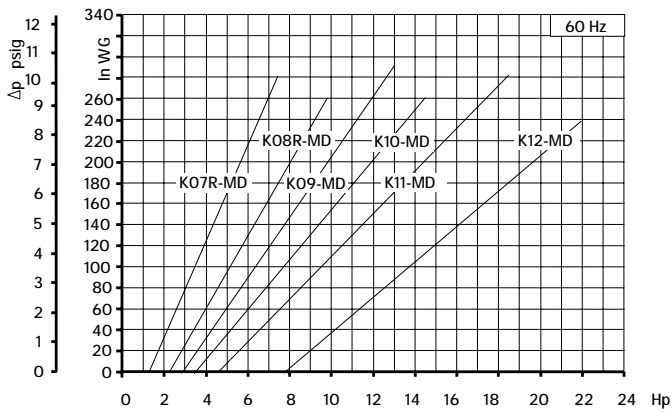
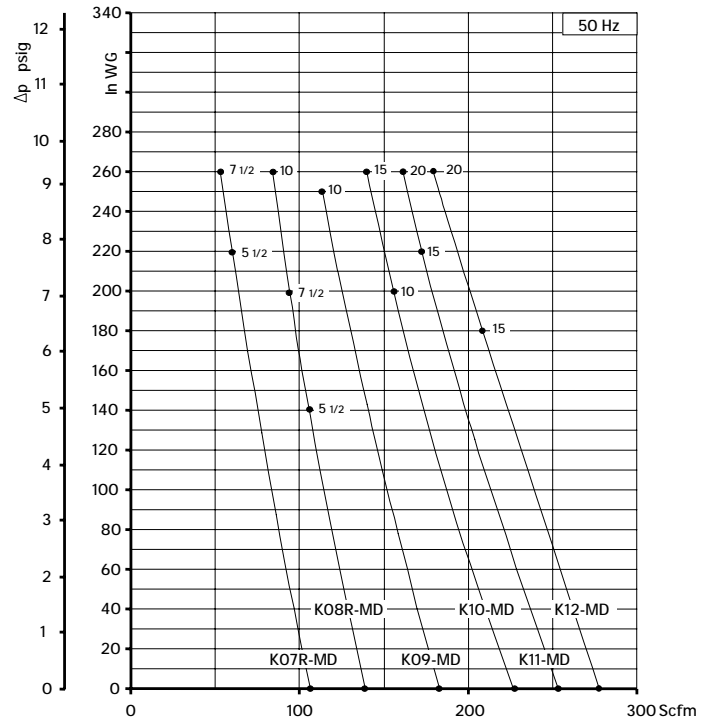
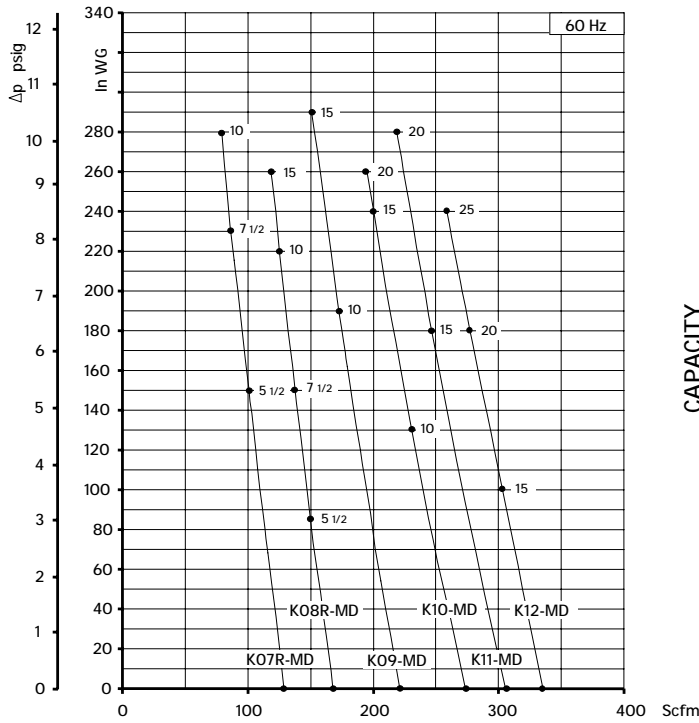

Curves refer to air at 68°F temperature and 29.92 In Hg atmospheric pressure (abs) measured at inlet port.  
Values for flow, power consumption and temperature rise: +/-10% tolerance.  
Data subject to change without notice.